



Stainless Steel Welding Fittings



ASTM A403 WELDED FITTINGS INDEX

90° LONG RADIUS ELBOWS.....	16
90° LONG RADIUS ELBOWS.....	17
90° SHORT RADIUS ELBOWS.....	18
90° SHORT RADIUS ELBOWS.....	19
45° LONG RADIUS ELBOWS.....	20
45° LONG RADIUS ELBOWS.....	21
CAPS.....	22
CAPS.....	23
STRAIGHT TEES.....	24
STRAIGHT TEES.....	25
REDUCING OUTLET TEES.....	26
REDUCING OUTLET TEES.....	27
REDUCING OUTLET TEES.....	28
REDUCING OUTLET TEES.....	29
CON. / ECC. REDUCERS.....	30
CON. / ECC. REDUCERS.....	31
CON. / ECC. REDUCERS.....	32
CON. / ECC. REDUCERS.....	33
LAP- JOINT STUB END / SHORT TYPE "A" OR "B".....	34
LAP- JOINT STUB END / STUB ENDS LONG TYPE "A".....	35
LAP- JOINT STUB END / STUB ENDS LONG TYPE "A".....	36
LAP- JOINT STUB END / STUB ENDS SHORT TYPE "C".....	37

90° LONG RADIUS ELBOWS

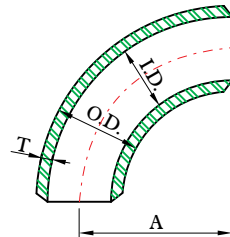
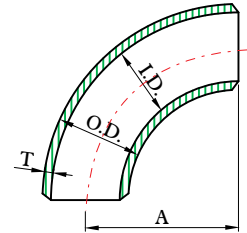
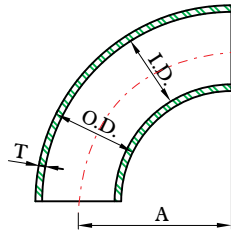

DIMENSIONS

unit : inch

Nominal pipe size	Outside diameter (O.D.)	Center to face (A)	Schedule 5S			Schedule 10S			Schedule 40S		
			Inside diameter (I.D.)	Wall thickness (T)	Approx. weight * *	Inside diameter (I.D.)	Wall thickness (T)	Approx. weight * *	Inside diameter (I.D.)	Wall thickness (T)	Approx. weight * *
1/2	.840	1-1/2	.710	.065	.12	.674	.083	.14	.622	.109	.18
3/4	1.050	1-1/2	.920	.065	.13	.884	.083	.15	.824	.113	.19
1	1.315	1-1/2	1.185	.065	.19	1.097	.109	.30	1.049	.133	.35
1-1/4	1.660	1-7/8	1.530	.065	.31	1.442	.109	.50	1.380	.140	.56
1-1/2	1.900	2-1/4	1.770	.065	.38	1.682	.109	.69	1.610	.145	.88
2	2.375	3	2.245	.065	.64	2.157	.109	1.13	2.067	.154	1.56
2-1/2	2.875	3-3/4	2.709	.083	1.50	2.635	.120	1.88	2.469	.203	3.00
3	3.500	4-1/2	3.334	.083	2.00	3.260	.120	2.69	3.068	.216	4.81
3-1/2	4.000	5-1/4	3.834	.083	2.62	3.760	.120	3.75	3.548	.226	6.25
4	4.500	6	4.334	.083	3.31	4.260	.120	4.75	4.026	.237	9.19
5	5.563	7-1/2	5.345	.109	6.50	5.295	.134	8.00	5.047	.258	15.13
6	6.625	9	6.407	.109	10.00	6.357	.134	12.00	6.065	.280	24.00
8	8.625	12	8.407	.109	17.30	8.329	.148	23.50	7.981	.322	47.50
10	10.750	15	10.482	.134	32.00	10.420	.165	43.00	10.020	.365	85.00
12	12.750	18	12.438	.156	51.00	12.390	.180	60.00	12.000	.375	131.00
14	14.000	21	13.688	.156	68.00	13.624	.188	80.00	13.250	.375	155.00
16	16.000	24	15.670	.165	100.00	15.624	.188	105.00	15.250	.375	202.00
18	18.000	27	17.670	.165	125.00	17.624	.188	132.00	17.250	.375	269.00
20	20.000	30	19.624	.188	165.00	19.564	.218	220.00	19.250	.375	330.00
24	24.000	36	23.564	.218	280.00	23.500	.250	310.00	23.250	.375	464.00

90° LONG RADIUS ELBOWS

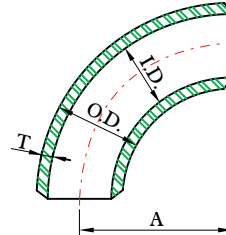
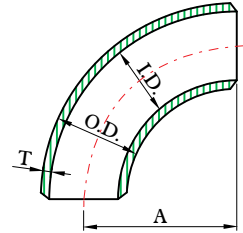
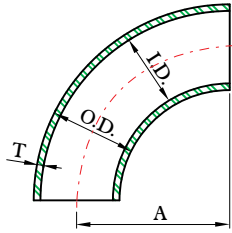

DIMENSIONS

unit : inch / lb

Nominal pipe size	Outside diameter (O.D.)	Center to face (A)	Schedule 80S			Schedule 160			XX Strong Wall		
			Inside diameter (I.D.)	Wall thickness (T)	Approx. weight * *	Inside diameter (I.D.)	Wall thickness (T)	Approx. weight * *	Inside diameter (I.D.)	Wall thickness (T)	Approx. weight * *
1/2	.840	1-1/2	.546	.147	.23	.464	.188	.29	.252	.294	.46
3/4	1.050	1-1/2	.742	.154	.25	.612	.219	.35	.434	.308	.50
1	1.315	1-1/2	.957	.179	.48	.815	.250	.67	.599	.358	.96
1-1/4	1.660	1-7/8	1.278	.191	.88	1.160	.250	1.15	.896	.382	1.76
1-1/2	1.900	2-1/4	1.500	.200	1.13	1.338	.281	1.59	1.100	.400	2.26
2	2.375	3	1.939	.218	2.00	1.689	.343	3.14	1.503	.436	4.00
2-1/2	2.875	3-3/4	2.323	.276	4.00	2.125	.375	5.44	1.771	.552	8.00
3	3.500	4-1/2	2.900	.300	6.56	2.624	.438	9.58	2.300	.600	13.12
3-1/2	4.000	5-1/4	3.364	.318	8.80	-----	-----	-----	2.728	.636	17.60
4	4.500	6	3.826	.337	13.63	3.438	.531	21.53	3.152	.674	27.26
5	5.563	7-1/2	4.813	.375	21.13	4.313	.625	35.29	4.063	.750	42.26
6	6.625	9	5.761	.432	36.00	5.187	.719	59.76	4.897	.864	72.00
8	8.625	12	7.625	.500	73.00	6.813	.906	132.00	6.875	.875	127.00
10	10.750	15	9.750	.500	114.00	8.500	1.125	256.00	-----	-----	-----
12	12.750	18	11.750	.500	175.00	10.126	1.312	458.00	-----	-----	-----
14	14.000	21	13.000	.500	206.00	11.188	1.406	-----	-----	-----	-----
16	16.000	24	15.000	.500	269.00	12.812	1.594	-----	-----	-----	-----
18	18.000	27	17.000	.500	350.00	14.438	1.781	-----	-----	-----	-----
20	20.000	30	19.000	.500	439.00	16.062	1.969	-----	-----	-----	-----
24	24.000	36	23.000	.500	617.00	19.312	2.344	-----	-----	-----	-----

90° SHORT RADIUS ELBOWS

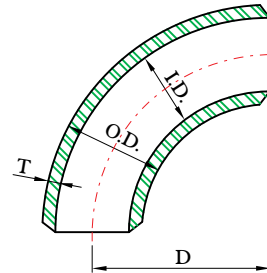
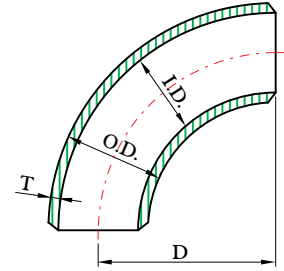
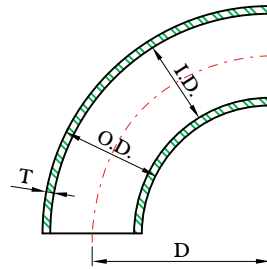

DIMENSIONS

unit : inch / lb

Nominal pipe size	Outside diameter (O.D.)	Center to face (D)	Schedule 5S			Schedule 10S			Schedule 40S		
			Inside diameter (I.D.)	Wall thickness (T)	Approx. weight * *	Inside diameter (I.D.)	Wall thickness (T)	Approx. weight * *	Inside diameter (I.D.)	Wall thickness (T)	Approx. weight * *
1	1.315	1	1.185	.065	.17	1.097	.109	.23	1.049	.133	.26
1-1/4	1.660	1-1/4	1.530	.065	.31	1.442	.109	.38	1.380	.140	.45
1-1/2	1.900	1-1/2	1.770	.065	.43	1.682	.109	.49	1.610	.145	.63
2	2.375	2	2.245	.065	.63	2.157	.109	.81	2.067	.154	1.13
2-1/2	2.875	2-1/2	2.709	.083	1.25	2.635	.120	1.36	2.469	.203	2.25
3	3.500	3	3.334	.083	1.75	3.260	.120	2.17	3.068	.216	3.31
3-1/2	4.000	3-1/2	3.834	.083	2.35	3.760	.120	3.05	3.548	.226	4.54
4	4.500	4	4.334	.083	3.12	4.260	.120	3.79	4.026	.237	6.88
5	5.563	5	5.345	.109	4.94	5.295	.134	6.12	5.047	.258	11.63
6	6.625	6	6.407	.109	7.75	6.357	.134	9.15	6.065	.280	17.50
8	8.625	8	8.407	.109	15.44	8.329	.148	17.63	7.981	.322	37.60
10	10.750	10	10.482	.134	27.40	10.420	.165	35.00	10.020	.365	63.00
12	12.750	12	12.438	.156	35.00	12.390	.180	40.00	12.000	.375	80.00
14	14.000	14	13.688	.156	44.00	13.624	.188	52.00	13.250	.375	101.00
16	16.000	16	15.670	.165	65.00	15.624	.188	68.00	15.250	.375	131.00
18	18.000	18	17.670	.165	81.00	17.624	.188	86.00	17.250	.375	175.00
20	20.000	20	19.624	.188	107.00	19.564	.218	143.00	19.250	.375	215.00
24	24.000	24	23.564	.218	182.00	23.500	.250	202.00	23.250	.375	302.00

90° SHORT RADIUS ELBOWS

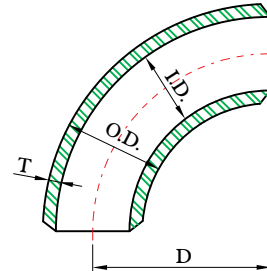
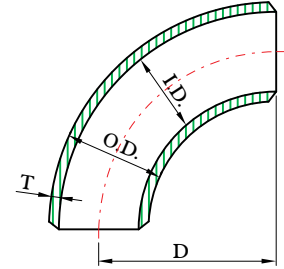
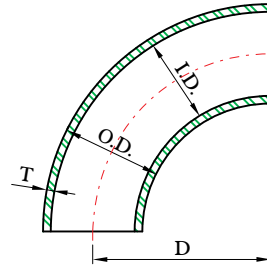

DIMENSIONS

unit : inch / lb

Nominal pipe size	Outside diameter (O.D.)	Center to face (D)	Schedule 80S			Schedule 160			XX Strong Wall		
			Inside diameter (I.D.)	Wall thickness (T)	Approx. weight **	Inside diameter (I.D.)	Wall thickness (T)	Approx. weight **	Inside diameter (I.D.)	Wall thickness (T)	Approx. weight **
1	1.315	1	.957	.179	.38	.815	.250	.53	.599	.358	.76
1-1/4	1.660	1-1/4	1.278	.191	.63	1.160	.250	.82	.896	.382	1.26
1-1/2	1.900	1-1/2	1.500	.200	.88	1.338	.281	1.23	1.100	.400	1.76
2	2.375	2	1.939	.218	1.55	1.689	.343	2.43	1.503	.436	3.10
2-1/2	2.875	2-1/2	2.323	.276	2.88	2.125	.375	3.88	1.771	.552	5.76
3	3.500	3	2.900	.300	4.20	2.624	.438	6.09	2.300	.600	8.40
3-1/2	4.000	3-1/2	3.364	.318	5.35	-----	-----	-----	2.728	.636	10.70
4	4.500	4	3.826	.337	9.06	3.438	.531	14.22	3.152	.674	18.12
5	5.563	5	4.813	.375	16.10	4.313	.625	26.72	4.063	.750	32.20
6	6.625	6	5.761	.432	26.00	5.187	.719	43.16	4.897	.864	52.00
8	8.625	8	7.625	.500	54.80	6.813	.906	99.18	6.875	.875	109.00
10	10.750	10	9.750	.500	99.80	8.500	1.125	224.00	-----	-----	-----
12	12.750	12	11.750	.500	125.00	10.126	1.312	327.00	-----	-----	-----
14	14.000	14	13.000	.500	135.00	11.188	1.406	-----	-----	-----	-----
16	16.000	16	15.000	.500	175.00	12.812	1.594	-----	-----	-----	-----
18	18.000	18	17.000	.500	228.00	14.438	1.781	-----	-----	-----	-----
20	20.000	20	19.000	.500	285.00	16.062	1.969	-----	-----	-----	-----
24	24.000	24	23.000	.500	401.00	19.312	2.344	-----	-----	-----	-----

45° LONG RADIUS ELBOWS

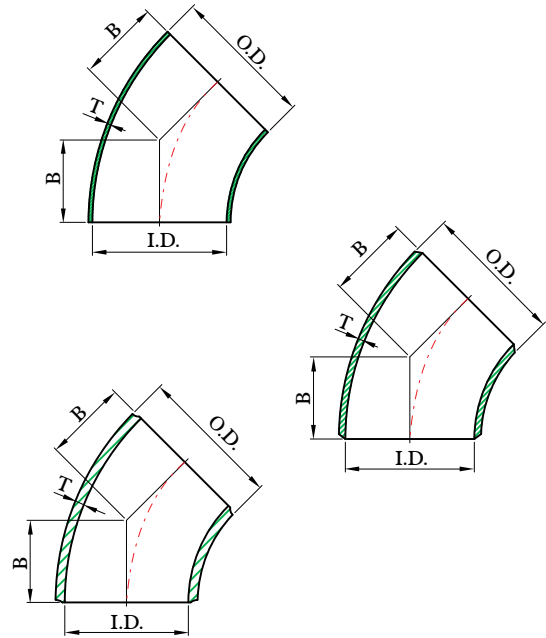

DIMENSIONS

unit : inch / lb

Nominal pipe size	Outside diameter (O.D.)	Center to face (B)	Schedule 5S			Schedule 10S			Schedule 40S		
			Inside diameter (I.D.)	Wall thickness (T)	Approx. weight * *	Inside diameter (I.D.)	Wall thickness (T)	Approx. weight * *	Inside diameter (I.D.)	Wall thickness (T)	Approx. weight * *
1/2	.840	5/8	.710	.065	.06	.674	.083	.07	.622	.109	.09
3/4	1.050	7/16	.920	.065	.06	.884	.083	.07	.824	.113	.09
1	1.315	7/8	1.185	.065	.12	1.097	.109	.19	1.049	.133	.25
1-1/4	1.660	1	1.530	.065	.19	1.442	.109	.25	1.380	.140	.38
1-1/2	1.900	1-1/8	1.770	.065	.25	1.682	.109	.38	1.610	.145	.50
2	2.375	1-3/8	2.245	.065	.31	2.157	.109	.56	2.067	.154	.88
2-1/2	2.875	1-3/4	2.709	.083	.75	2.635	.120	1.06	2.469	.203	1.69
3	3.500	2	3.334	.083	1.06	3.260	.120	1.38	3.068	.216	2.38
3-1/2	4.000	2-1/4	3.834	.083	1.16	3.760	.120	1.66	3.548	.226	3.13
4	4.500	2-1/2	4.334	.083	1.66	4.260	.120	2.38	4.026	.237	4.60
5	5.563	3-1/8	5.345	.109	3.25	5.295	.134	4.00	5.047	.258	7.57
6	6.625	3-3/4	6.407	.109	5.00	6.357	.134	6.00	6.065	.280	12.00
8	8.625	5	8.407	.109	8.65	8.329	.148	11.75	7.981	.322	23.75
10	10.750	6-1/4	10.482	.134	16.00	10.420	.165	21.50	10.020	.365	42.50
12	12.750	7-1/2	12.438	.156	25.50	12.390	.180	30.00	12.000	.375	65.50
14	14.000	8-3/4	13.688	.156	34.00	13.624	.188	40.00	13.250	.375	77.50
16	16.000	10	15.670	.165	50.00	15.624	.188	52.50	15.250	.375	101.00
18	18.000	11-1/4	17.670	.165	62.50	17.624	.188	66.00	17.250	.375	131.00
20	20.000	12-1/2	19.624	.188	82.50	19.564	.218	110.00	19.250	.375	165.00
24	24.000	15	23.564	.218	140.00	23.500	.250	155.00	23.250	.375	232.00

45° LONG RADIUS ELBOWS

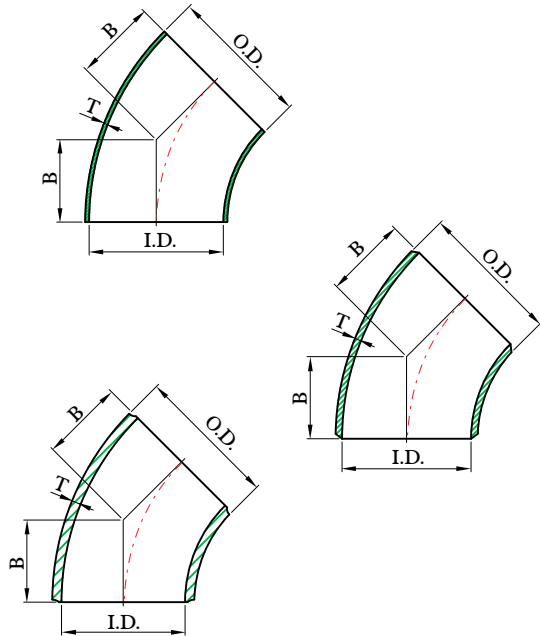

DIMENSIONS

unit : inch / lb

Nominal pipe size	Outside diameter (O.D.)	Center to face (B)	Schedule 80S			Schedule 160			XX Strong Wall		
			Inside diameter (I.D.)	Wall thickness (T)	Approx. weight * *	Inside diameter (I.D.)	Wall thickness (T)	Approx. weight * *	Inside diameter (I.D.)	Wall thickness (T)	Approx. weight * *
1/2	.840	5/8	.546	.147	.12	.464	.188	.16	.252	.294	.24
3/4	1.050	7/16	.742	.154	.12	.612	.219	.16	.434	.308	.24
1	1.315	7/8	.957	.179	.31	.815	.250	.43	.599	.358	.62
1-1/4	1.660	1	1.278	.191	.50	1.160	.250	.85	.896	.382	1.00
1-1/2	1.900	1-1/8	1.500	.200	.63	1.338	.281	.88	1.100	400	1.26
2	2.375	1-3/8	1.939	.218	1.13	1.689	.343	1.77	1.503	436	2.26
2-1/2	2.875	1-3/4	2.323	.276	2.19	2.125	.375	2.95	1.771	552	4.38
3	3.500	2	2.900	.300	3.31	2.624	.438	4.80	2.300	600	6.62
3-1/2	4.000	2-1/4	3.364	.318	4.40	-----	-----	-----	2.728	636	8.80
4	4.500	2-1/2	3.826	.337	6.82	3.438	.531	10.87	3.152	.674	13.64
5	5.563	3-1/8	4.813	.375	10.56	4.313	.625	17.52	4.063	.750	21.12
6	6.625	3-3/4	5.761	.432	18.00	5.187	.719	20.88	4.897	.864	36.00
8	8.625	5	7.625	.500	36.50	6.813	.906	64.24	6.875	.875	63.87
10	10.750	6-1/4	9.750	.500	57.00	8.500	1.125	127.00	-----	-----	-----
12	12.750	7-1/2	11.750	.500	87.50	10.126	1.312	229.00	-----	-----	-----
14	14.000	8-3/4	13.000	.500	103.00	11.188	1.406	-----	-----	-----	-----
16	16.000	10	15.000	.500	134.00	12.812	1.594	-----	-----	-----	-----
18	18.000	11-1/4	17.000	.500	175.00	14.438	1.781	-----	-----	-----	-----
20	20.000	12-1/2	19.000	.500	219.00	16.062	1.969	-----	-----	-----	-----
24	24.000	15	23.000	.500	308.00	19.312	2.344	-----	-----	-----	-----

CAPS

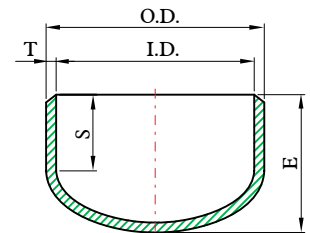
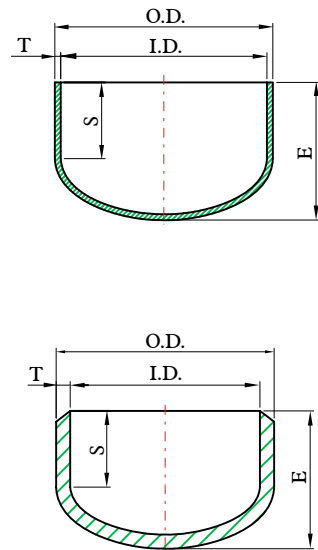

DIMENSIONS

unit : inch / lb

Nominal pipe size	Outside diameter (O.D.)	Length (E)	Tangent Length (S)	Schedule 5S			Schedule 10S			Schedule 40S		
				Inside diameter (I.D.)	Wall thickness (T)	Approx. weight * *	Inside diameter (I.D.)	Wall thickness (T)	Approx. weight * *	Inside diameter (I.D.)	Wall thickness (T)	Approx. weight * *
1/2	.840	1	.74	.710	.065	.08	.674	.083	.09	.622	.109	.10
3/4	1.050	1	.68	.920	.065	.11	.884	.083	.12	.824	.113	.13
1	1.315	1-1/2	1.10	1.185	.065	.18	1.097	.109	.19	1.049	.133	.28
1-1/4	1.660	1-1/2	1.02	1.530	.065	.20	1.442	.109	.28	1.380	.140	.38
1-1/2	1.900	1-1/2	.95	1.770	.065	.22	1.682	.109	.31	1.610	.145	.50
2	2.375	1-1/2	.83	2.245	.065	.36	2.157	.109	.38	2.067	.154	.60
2-1/2	2.875	1-1/2	.68	2.709	.083	.50	2.635	.120	.56	2.469	.203	1.00
3	3.500	2	1.02	3.334	.083	.86	3.260	.120	.88	3.068	.216	1.56
3-1/2	4.000	2-1/2	1.40	3.834	.083	1.20	3.760	.120	1.25	3.548	.226	2.25
4	4.500	2-1/2	1.26	4.334	.083	1.25	4.260	.120	1.44	4.026	.237	2.69
5	5.563	3	1.48	5.345	.109	2.00	5.295	.134	2.25	5.047	.258	4.06
6	6.625	3-1/2	1.70	6.407	.109	2.75	6.357	.134	3.00	6.065	.280	7.12
8	8.625	4	1.68	8.407	.109	4.50	8.329	.148	5.50	7.981	.322	12.50
10	10.750	5	2.13	10.482	.134	9.50	10.420	.165	10.80	10.020	.365	20.30
12	12.750	6	2.63	12.438	.156	14.00	12.390	.180	14.40	12.000	.375	28.80
14	14.000	6-1/2	2.81	13.688	.156	17.00	13.624	.188	18.00	13.250	.375	35.70
16	16.000	7	2.81	15.670	.165	30.00	15.624	.188	32.00	15.250	.375	48.50
18	18.000	8	3.31	17.670	.165	38.00	17.624	.188	39.60	17.250	.375	59.40
20	20.000	9	3.81	19.624	.188	55.00	19.564	.218	60.00	19.250	.375	75.00
24	24.000	10-1/2	4.31	23.564	.218	75.00	23.500	.250	76.00	23.250	.375	98.00

CAPS

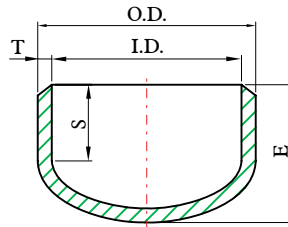
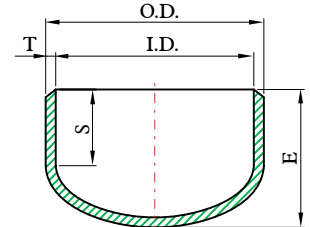
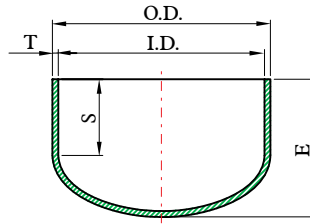

DIMENSIONS

unit : inch / lb

Nominal pipe size	Outside diameter (O.D.)	Length (E) Tangent Length (S)	Length (E1) Tangent Length (S)	Schedule 80S			Schedule 160			XX Strong Wall		
				Inside diameter (I.D.)	Wall thickness (T)	Approx. weight * *	Inside diameter (I.D.)	Wall thickness (T)	Approx. weight * *	Inside diameter (I.D.)	Wall thickness (T)	Approx. weight * *
1/2	.840	E 1 S .72	E1 1 S .64	.546	.147	.11	.464	.188	.14	.252	.294	.22
3/4	1.050	E 1 S .66	E1 1 S .58	.742	.154	.14	.612	.219	.20	.434	.308	.28
1	1.315	E 1-1/2 S 1.08	E1 1-1/2 S .99	.957	.179	.29	.815	.250	.40	.599	.358	.58
1-1/4	1.660	E 1-1/2 S .99	E1 1-1/2 S .89	1.278	.191	.39	1.160	.250	.50	.896	.382	.78
1-1/2	1.900	E 1-1/2 S .93	E1 1-1/2 S .83	1.500	.200	.54	1.338	.281	.75	1.100	.400	1.08
2	2.375	E 1-1/2 S .80	E1 1-3/4 S .95	1.939	.218	.75	1.689	.343	1.17	1.503	.436	1.50
2-1/2	2.875	E 1-1/2 S .64	E1 2 S 1.01	2.323	.276	1.12	2.125	.375	1.48	1.771	.552	2.24
3	3.500	E 2 S .98	E1 2-1/2 S 1.32	2.900	.300	1.87	2.624	.438	2.71	2.300	.600	3.74
3-1/2	4.000	E 2-1/2 S 1.34	E1 3 S 1.70	3.364	.318	2.50	-----	-----	-----	2.728	.636	5.00
4	4.500	E 2-1/2 S 1.21	E1 3 S 1.60	3.826	.337	3.54	3.438	.531	5.55	3.152	.674	7.08
5	5.563	E 3 S 1.42	E1 3-1/2 S 1.73	4.813	.375	5.63	4.313	.625	9.34	4.063	.750	11.26
6	6.625	E 3-1/2 S 1.63	E1 4 S 1.91	5.761	.432	10.00	5.187	.719	16.00	4.897	.864	20.00
8	8.625	E 4 S 1.59	E1 5 S 2.41	7.625	.500	16.38	6.813	.906	29.64	6.875	.875	22.76
10	10.750	E 5 S 2.06	E1 6 S 2.75	9.750	.500	27.30	8.500	1.125	61.42	-----	-----	-----
12	12.750	E 6 S 2.56	E1 7 S 3.16	11.750	.500	36.60	10.126	1.312	95.00	-----	-----	-----
14	14.000	E 6-1/2 S 2.75	-----	13.000	.500	48.00	11.188	1.406	-----	-----	-----	-----
16	16.000	E 7 S 2.75	-----	15.000	.500	65.00	12.812	1.594	-----	-----	-----	-----
18	18.000	E 8 S 3.25	-----	17.000	.500	79.20	14.438	1.781	-----	-----	-----	-----
20	20.000	E 9 S 3.75	-----	19.000	.500	88.00	16.062	1.969	-----	-----	-----	-----
24	24.000	E 10-1/2 S 4.25	-----	23.000	.500	135.00	19.312	2.344	-----	-----	-----	-----

STRAIGHT TEES

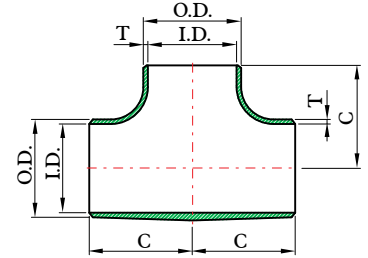
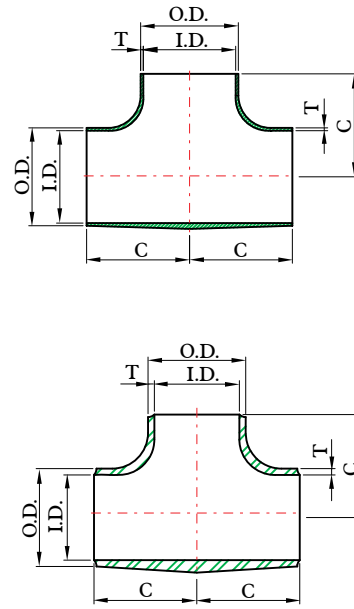

DIMENSIONS

unit : inch / lb

Nominal pipe size	Outside diameter (O.D.)	Center to end (C)	Schedule 5S			Schedule 10S			Schedule 40S		
			Inside diameter (I.D.)	Wall thickness (T)	Approx. weight * *	Inside diameter (I.D.)	Wall thickness (T)	Approx. weight * *	Inside diameter (I.D.)	Wall thickness (T)	Approx. weight * *
1/2	.840	1	.710	.065	.19	.674	.083	.21	.622	.109	.23
3/4	1.050	1-1/8	.920	.065	.22	.884	.083	.28	.824	.113	.38
1	1.315	1-1/2	1.185	.065	.40	1.097	.109	.63	1.049	.133	.65
1-1/4	1.660	1-7/8	1.530	.065	.75	1.442	.109	1.10	1.380	.140	1.31
1-1/2	1.900	2-1/4	1.770	.065	.95	1.682	.109	1.50	1.610	.145	1.90
2	2.375	2-1/2	2.245	.065	1.20	2.157	.109	1.87	2.067	.154	2.83
2-1/2	2.875	3	2.709	.083	2.15	2.635	.120	3.10	2.469	.203	4.85
3	3.500	3-3/8	3.334	.083	3.40	3.260	.120	3.90	3.068	.216	7.30
3-1/2	4.000	3-3/4	3.834	.083	5.50	3.760	.120	5.88	3.548	.226	9.00
4	4.500	4-1/8	4.334	.083	7.20	4.260	.120	7.63	4.026	.237	11.63
5	5.563	4-7/8	5.345	.109	13.00	5.295	.134	13.45	5.047	.258	20.75
6	6.625	5-5/8	6.407	.109	17.20	6.357	.134	17.80	6.065	.280	24.25
8	8.625	7	8.407	.109	31.00	8.329	.148	34.50	7.981	.322	46.10
10	10.750	8-1/2	10.482	.134	55.00	10.420	.165	59.00	10.020	.365	78.00
12	12.750	10	12.438	.156	83.00	12.390	.180	87.00	12.000	.375	137.00
14	14.000	11	13.688	.156	89.00	13.624	.188	107.00	13.250	.375	175.00
16	16.000	12	15.670	.165	115.00	15.624	.188	130.00	15.250	.375	220.00
18	18.000	13-1/2	17.670	.165	149.00	17.624	.188	169.00	17.250	.375	286.00
20	20.000	15	19.624	.188	171.00	19.564	.218	228.00	19.250	.375	358.00
24	24.000	17	23.564	.218	298.00	23.500	.250	343.00	23.250	.375	498.00

STRAIGHT TEES

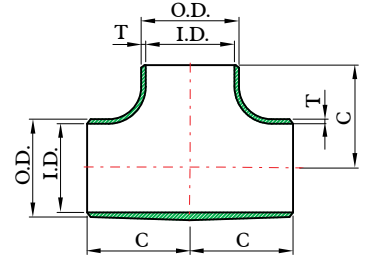
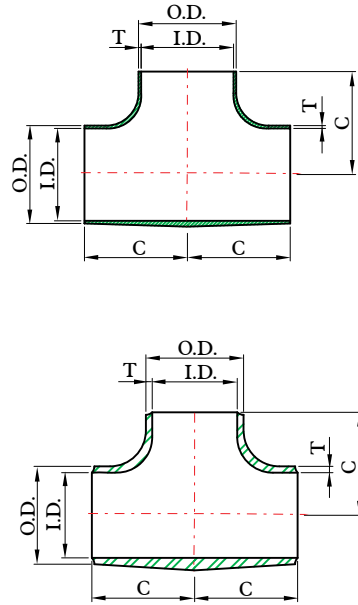

DIMENSIONS

unit : inch / lb

Nominal pipe size	Outside diameter (O.D.)	Center to end (C)	Schedule 80S			Schedule 160S			XX Strong Wall		
			Inside diameter (I.D.)	Wall thickness (T)	Approx. weight **	Inside diameter (I.D.)	Wall thickness (T)	Approx. weight **	Inside diameter (I.D.)	Wall thickness (T)	Approx. weight **
1/2	.840	1	.546	.147	.30	.464	.188	.38	.252	.294	.60
3/4	1.050	1-1/8	.742	.154	.45	.612	.219	.64	.434	.308	.90
1	1.315	1-1/2	.957	.179	.85	.815	.250	1.19	.599	.358	1.70
1-1/4	1.660	1-7/8	1.278	.191	1.50	1.160	.250	1.97	.896	.382	3.00
1-1/2	1.900	2-1/4	1.500	.200	2.25	1.338	.281	3.15	1.100	.400	4.50
2	2.375	2-1/2	1.939	.218	3.50	1.689	.343	5.50	1.503	.436	7.00
2-1/2	2.875	3	2.323	.276	6.90	2.125	.375	9.38	1.771	.552	13.80
3	3.500	3-3/8	2.900	.300	9.80	2.624	.438	14.31	2.300	.600	19.60
3-1/2	4.000	3-3/4	3.364	.318	12.00	-----	-----	-----	2.728	.636	24.00
4	4.500	4-1/8	3.826	.337	17.00	3.438	.531	26.86	3.152	.674	34.00
5	5.563	4-7/8	4.813	.375	25.00	4.313	.625	41.75	4.063	.750	50.00
6	6.625	5-5/8	5.761	.432	30.00	5.187	.719	49.80	4.897	.864	60.00
8	8.625	7	7.625	.500	62.00	6.813	.906	112.00	6.875	.875	108.00
10	10.750	8-1/2	9.750	.500	110.00	8.500	1.125	247.00	-----	-----	-----
12	12.750	10	11.750	.500	185.00	10.126	1.312	484.00	-----	-----	-----
14	14.000	11	13.000	.500	210.00	11.188	1.406	590.00	-----	-----	-----
16	16.000	12	15.000	.500	265.00	12.812	1.594	812.00	-----	-----	-----
18	18.000	13-1/2	17.000	.500	344.00	14.438	1.781	1097.00	-----	-----	-----
20	20.000	15	19.000	.500	430.00	16.062	1.969	1690.00	-----	-----	-----
24	24.000	17	23.000	.500	600.00	19.312	2.344	2950.00	-----	-----	-----

CON. / ECC. REDUCERS

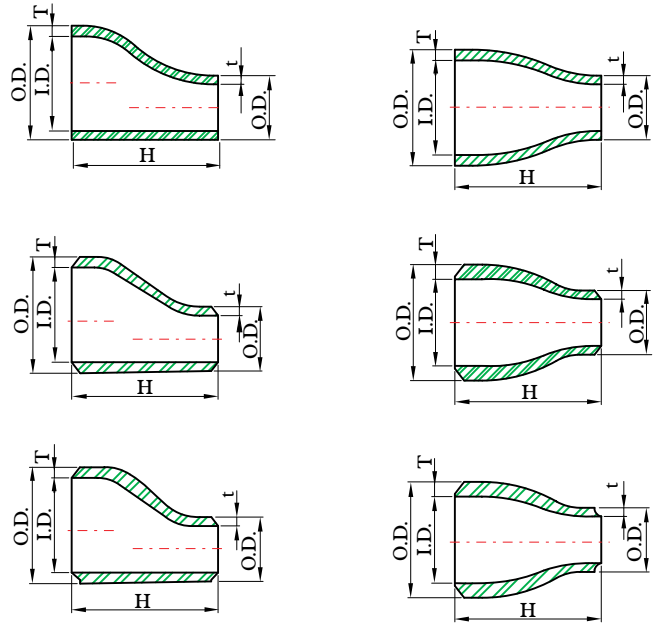

DIMENSIONS

unit : inch / lb

Nominal Pipe Size <small>Large End X Small End</small>	Outside Diameter Large End (O.D.)	Outside Diameter Small End (O.D)	Length (H)	Schedule 5S					Schedule 10S					Schedule 40S				
				Inside Diameter Large End (I.D.)	Inside Diameter Small End (I.D.)	Wall Thickness Large End (T)	Wall Thickness Small End (t)	Approximate Weight **	Inside Diameter Large End (I.D.)	Inside Diameter Small End (I.D.)	Wall Thickness Large End (T)	Wall Thickness Small End (t)	Approximate Weight **	Inside Diameter Large End (I.D.)	Inside Diameter Small End (I.D.)	Wall Thickness Large End (T)	Wall Thickness Small End (t)	Approximate Weight **
3/4x 3/8	1.050	.675	1-1/2	.920	.545	.065	.065	.15	.884	.545	.083	.065	.20	.824	.493	.113	.091	.27
3/4x 1/2	1.050	.840	1-1/2	.920	.710	.065	.065	.17	.884	.674	.083	.083	.22	.824	.622	.113	.109	.31
1 x 3/8	1.315	.675	2	1.185	.545	.065	.065	.16	1.097	.545	.109	.065	.21	1.049	.493	.133	.091	.33
1 x 1/2	1.315	.840	2	1.185	.710	.065	.065	.16	1.097	.674	.109	.083	.27	1.049	.622	.133	.109	.34
1 x 3/4	1.315	1.050	2	1.185	.920	.065	.065	.17	1.097	.884	.109	.083	.29	1.049	.824	.133	.113	.36
1-1/4 x 1/2	1.660	.840	2	1.530	.710	.065	.065	.21	1.442	.674	.109	.083	.35	1.380	.622	.140	.109	.46
1-1/4 x 3/4	1.660	1.050	2	1.530	.920	.065	.065	.22	1.442	.884	.109	.083	.39	1.380	.824	.140	.113	.49
1-1/4 x 1	1.660	1.315	2	1.530	1.185	.065	.065	.22	1.442	1.097	.109	.109	.39	1.380	1.049	.140	.133	.49
1-1/2 x 1/2	1.900	.840	2-1/2	1.770	.710	.065	.065	.23	1.682	.674	.109	.083	.37	1.610	.622	.145	.109	.50
1-1/2 x 3/4	1.900	1.050	2-1/2	1.770	.920	.065	.065	.24	1.682	.884	.109	.083	.39	1.610	.824	.145	.113	.52
1-1/2 x 1	1.900	1.315	2-1/2	1.770	1.185	.065	.065	.25	1.682	1.097	.109	.109	.43	1.610	1.049	.145	.133	.58
1-1/2 x 1-1/4	1.900	1.660	2-1/2	1.770	1.530	.065	.065	.27	1.682	1.442	.109	.109	.46	1.610	1.380	.145	.140	.62
2 x 3/4	2.375	1.050	3	2.245	.920	.065	.065	.33	2.157	.884	.109	.083	.56	2.067	.824	.154	.113	.80
2 x 1	2.375	1.315	3	2.245	1.185	.065	.065	.37	2.157	1.097	.109	.109	.62	2.067	1.049	.154	.133	.89
2 x 1-1/4	2.375	1.660	3	2.245	1.530	.065	.065	.40	2.157	1.442	.109	.109	.67	2.067	1.380	.154	.140	.96
2 x 1-1/2	2.375	1.900	3	2.245	1.770	.065	.065	.41	2.157	1.682	.109	.109	.69	2.067	1.610	.154	.145	.99
2-1/2 x 1	2.875	1.315	3-1/2	2.709	1.185	.083	.065	.56	2.635	1.097	.120	.109	.83	2.469	1.049	.203	.133	1.42
2-1/2 x 1-1/4	2.875	1.660	3-1/2	2.709	1.530	.083	.065	.64	2.635	1.442	.120	.109	.95	2.469	1.380	.203	.140	1.61
2-1/2 x 1-1/2	2.875	1.900	3-1/2	2.709	1.770	.083	.065	.67	2.635	1.682	.120	.109	.98	2.469	1.610	.203	.145	1.67
2-1/2 x 2	2.875	2.375	3-1/2	2.709	2.245	.083	.065	.70	2.635	2.157	.120	.109	1.03	2.469	2.067	.203	.154	1.76
3 x 1	3.500	1.315	3-1/2	3.334	1.185	.083	.065	.70	3.260	1.097	.120	.109	1.03	3.068	1.049	.216	.133	1.81
3 x 1-1/4	3.500	1.660	3-1/2	3.334	1.530	.083	.065	.70	3.260	1.442	.120	.109	1.03	3.068	1.380	.216	.140	1.86
3 x 1-1/2	3.500	1.900	3-1/2	3.334	1.770	.083	.065	.78	3.260	1.682	.120	.109	1.13	3.068	1.610	.216	.145	2.07
3 x 2	3.500	2.375	3-1/2	3.334	2.245	.083	.065	.83	3.260	2.157	.120	.109	1.21	3.068	2.067	.216	.154	2.20
3 x 2-1/2	3.500	2.875	3-1/2	3.334	2.709	.083	.083	.90	3.260	2.635	.120	.120	1.30	3.068	2.469	.216	.203	2.38
3-1/2 x 1-1/4	4.000	1.660	4	3.834	1.530	.083	.065	.93	3.760	1.442	.120	.109	1.37	3.548	1.380	.226	.140	2.60
3-1/2 x 1-1/2	4.000	1.900	4	3.834	1.770	.083	.065	.99	3.760	1.682	.120	.109	1.46	3.548	1.610	.226	.145	2.76
3-1/2 x 2	4.000	2.375	4	3.834	2.245	.083	.065	1.06	3.760	2.157	.120	.109	1.57	3.548	2.067	.226	.154	2.97
3-1/2 x 2-1/2	4.000	2.875	4	3.834	2.709	.083	.083	1.17	3.760	2.635	.120	.120	1.72	3.548	2.469	.226	.203	3.25
3-1/2 x 3	4.000	3.500	4	3.834	3.334	.083	.083	1.20	3.760	3.260	.120	.120	1.77	3.548	3.068	.226	.216	3.35
4 x 1-1/2	4.500	1.900	4	4.334	1.770	.083	.065	1.05	4.260	1.682	.120	.109	1.50	4.026	1.610	.237	.145	3.00
4 x 2	4.500	2.375	4	4.334	2.245	.083	.065	1.21	4.260	2.157	.120	.109	1.73	4.026	2.067	.237	.154	3.47
4 x 2-1/2	4.500	2.875	4	4.334	2.709	.083	.083	1.28	4.260	2.635	.120	.120	1.83	4.026	2.469	.237	.203	3.66
4 x 3	4.500	3.500	4	4.334	3.334	.083	.083	1.34	4.260	3.260	.120	.120	1.92	4.026	3.068	.237	.216	3.84
4 x 3-1/2	4.500	4.000	4	4.334	3.834	.083	.083	1.38	4.260	3.760	.120	.120	1.98	4.026	3.548	.237	.226	3.97

CON. / ECC. REDUCERS

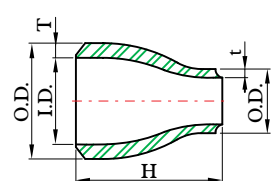
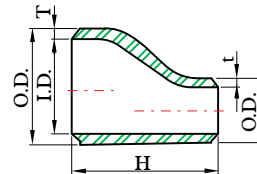
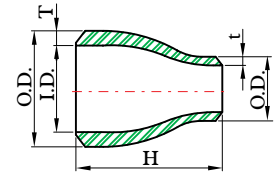
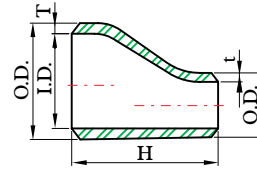
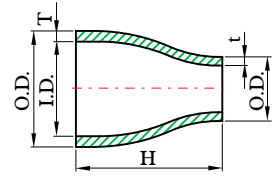
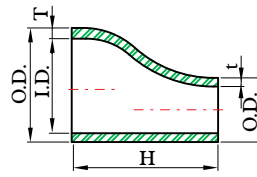

DIMENSIONS

unit : inch / lb

Nominal Pipe Size <small>Large End X Small End</small>	Outside Diameter Large End (O.D.)	Outside Diameter Small End (O.D.)	Length (H)	Schedule 80S					Schedule 160					XX Strong Wall					
				Inside Diameter Large End (I.D.)	Inside Diameter Small End (I.D.)	Wall Thickness Large End (T)	Wall Thickness Small End (t)	Approximate Weight **	Inside Diameter Large End (I.D.)	Inside Diameter Small End (I.D.)	Wall Thickness Large End (T)	Wall Thickness Small End (t)	Approximate Weight **	Inside Diameter Large End (I.D.)	Inside Diameter Small End (I.D.)	Wall Thickness Large End (T)	Wall Thickness Small End (t)	Approximate Weight **	
3/4 x 3/8	1.050	.675	1-1/2	.742	.423	.154	.126	.37	-----	-----	-----	-----	-----	-----	-----	-----	-----	-----	-----
3/4 x 1/2	1.050	.840	1-1/2	.742	.546	.154	.147	.40	.612	.466	.219	.187	.55	.434	.252	.308	.294	.80	-----
1 x 3/8	1.315	.675	2	.957	.423	.179	.126	.42	-----	-----	-----	-----	-----	-----	-----	-----	-----	-----	-----
1 x 1/2	1.315	.840	2	.957	.546	.179	.147	.44	.815	.466	.250	.187	.57	.599	.252	.358	.294	.88	-----
1 x 3/4	1.315	1.050	2	.957	.742	.179	.154	.49	.815	.612	.250	.219	.61	.599	.434	.358	.308	.98	-----
1-1/4 x 1/2	1.660	.840	2	1.278	.546	.191	.147	.52	1.160	.466	.250	.187	.67	.896	.252	.382	.294	1.04	-----
1-1/4 x 3/4	1.660	1.050	2	1.278	.742	.191	.154	.56	1.160	.612	.250	.219	.73	.896	.434	.382	.308	1.12	-----
1-1/4 x 1	1.660	1.315	2	1.278	.957	.191	.179	.59	1.160	.815	.250	.250	.82	.896	.599	.382	.358	1.18	-----
1-1/2 x 1/2	1.900	.840	2-1/2	1.500	.546	.200	.147	.68	1.338	.466	.281	.187	.95	1.100	.252	.400	.294	1.36	-----
1-1/2 x 3/4	1.900	1.050	2-1/2	1.500	.742	.200	.154	.71	1.338	.612	.281	.219	.99	1.100	.434	.400	.308	1.42	-----
1-1/2 x 1	1.900	1.315	2-1/2	1.500	.957	.200	.179	.74	1.338	.815	.281	.250	1.03	1.100	.599	.400	.358	1.48	-----
1-1/2 x 1-1/4	1.900	1.660	2-1/2	1.500	1.278	.200	.191	.80	1.338	1.160	.281	.250	1.12	1.100	.896	.400	.382	1.60	-----
2 x 3/4	2.375	1.050	3	1.939	.742	.218	.154	1.11	1.689	.612	.343	.219	1.74	1.503	.434	.436	.308	2.22	-----
2 x 1	2.375	1.315	3	1.939	.957	.218	.179	1.18	1.689	.815	.343	.250	1.85	1.503	.599	.436	.358	2.36	-----
2 x 1-1/4	2.375	1.660	3	1.939	1.278	.218	.191	1.27	1.689	1.160	.343	.250	1.99	1.503	.896	.436	.382	2.54	-----
2 x 1-1/2	2.375	1.900	3	1.939	1.500	.218	.200	1.30	1.689	1.338	.343	.281	2.04	1.503	1.100	.436	.400	2.60	-----
2-1/2 x 1	2.875	1.315	3-1/2	2.323	.957	.276	.179	1.92	2.125	.815	.375	.250	2.59	1.771	.599	.552	.358	3.84	-----
2-1/2 x 1-1/4	2.875	1.660	3-1/2	2.323	1.278	.276	.191	1.98	2.125	1.160	.375	.250	2.67	1.771	.896	.552	.382	3.96	-----
2-1/2 x 1-1/2	2.875	1.900	3-1/2	2.323	1.500	.276	.200	2.07	2.125	1.338	.375	.281	2.79	1.771	1.100	.552	.400	4.14	-----
2-1/2 x 2	2.875	2.375	3-1/2	2.323	1.939	.276	.218	2.26	2.125	1.689	.375	.343	3.05	1.771	1.503	.552	.436	4.52	-----
3 x 1	3.500	1.315	3-1/2	2.900	.957	.300	.179	2.39	2.624	.815	.438	.250	3.32	2.300	.599	.600	.358	4.76	-----
3 x 1-1/4	3.500	1.660	3-1/2	2.900	1.278	.300	.191	2.51	2.624	1.160	.438	.250	3.63	2.300	.896	.600	.382	5.02	-----
3 x 1-1/2	3.500	1.900	3-1/2	2.900	1.500	.300	.200	2.66	2.624	1.338	.438	.281	3.85	2.300	1.100	.600	.400	5.32	-----
3 x 2	3.500	2.375	3-1/2	2.900	1.939	.300	.218	2.85	2.624	1.689	.438	.343	4.13	2.300	1.503	.600	.436	5.70	-----
3 x 2-1/2	3.500	2.875	3-1/2	2.900	2.323	.300	.276	3.28	2.624	2.125	.438	.375	4.75	2.300	1.771	.600	.552	6.56	-----
3-1/2 x 1-1/4	4.000	1.660	4	3.364	1.278	.318	.191	3.53	-----	-----	-----	-----	-----	2.728	.896	.636	.382	7.06	-----
3-1/2 x 1-1/2	4.000	1.900	4	3.364	1.500	.318	.200	3.69	-----	-----	-----	-----	-----	2.728	1.100	.636	.400	7.38	-----
3-1/2 x 2	4.000	2.375	4	3.364	1.939	.318	.218	3.87	-----	-----	-----	-----	-----	2.728	1.503	.636	.436	7.74	-----
3-1/2 x 2-1/2	4.000	2.875	4	3.364	2.323	.318	.276	4.21	-----	-----	-----	-----	-----	2.728	1.771	.636	.552	8.42	-----
3-1/2 x 3	4.000	3.500	4	3.364	2.900	.318	.300	4.46	-----	-----	-----	-----	-----	2.728	2.300	.636	.600	8.96	-----
4 x 1-1/2	4.500	1.900	4	3.826	1.500	.337	.200	4.18	3.438	1.338	.531	.281	6.56	3.152	1.100	.674	.400	8.32	-----
4 x 2	4.500	2.375	4	3.826	1.939	.337	.218	4.31	3.438	1.689	.531	.343	6.76	3.152	1.503	.674	.436	8.62	-----
4 x 2-1/2	4.500	2.875	4	3.826	2.323	.337	.276	4.83	3.438	2.125	.531	.375	7.58	3.152	1.771	.674	.552	9.66	-----
4 x 3	4.500	3.500	4	3.826	2.900	.337	.300	5.14	3.438	2.624	.531	.438	8.07	3.152	2.300	.674	.600	10.28	-----
4 x 3-1/2	4.500	4.000	4	3.826	3.364	.337	.318	5.33	-----	-----	-----	-----	-----	3.152	2.728	.674	.636	10.66	-----

CON. / ECC. REDUCERS

DIMENSIONS

unit : inch / lb

Nominal Pipe Size <small>Large End X Small End</small>	Outside Diameter Large End (O.D.)	Outside Diameter Small End (O.D)	Length (H)	Schedule 5S					Schedule 10S					Schedule 40S				
				Inside Diameter Large End (I.D.)	Inside Diameter Small End (I.D.)	Wall Thickness Large End (T)	Wall Thickness Small End (t)	Approximate Weight**	Inside Diameter Large End (I.D.)	Inside Diameter Small End (I.D.)	Wall Thickness Large End (T)	Wall Thickness Small End (t)	Approximate Weight**	Inside Diameter Large End (I.D.)	Inside Diameter Small End (I.D.)	Wall Thickness Large End (T)	Wall Thickness Small End (t)	Approximate Weight**
5 x 2	5.563	2.375	5	5.345	2.245	.109	.065	2.33	5.295	2.157	.134	.109	2.83	5.047	2.067	.258	.154	5.55
5 x 2-1/2	5.563	2.875	5	5.345	2.709	.109	.083	2.55	5.295	2.635	.134	.120	3.09	5.047	2.469	.258	.203	6.07
5x3	5.563	3.500	5	5.345	3.334	.109	.083	2.64	5.295	3.260	.134	.120	3.20	5.047	3.068	.258	.216	6.29
5x3-1/2	5.563	4.000	5	5.345	3.834	.109	.083	2.71	5.295	3.760	.134	.120	3.28	5.047	3.548	.258	.226	6.45
5x 4	5.563	4.500	5	5.345	4.334	.109	.083	2.76	5.295	4.260	.134	.120	3.29	5.047	4.026	.258	.237	6.57
6x2-1/2	6.625	2.875	5-1/2	6.407	2.709	.109	.083	3.18	6.357	2.635	.134	.120	3.35	6.065	2.469	.280	.203	8.37
6x3	6.625	3.500	5-1/2	6.407	3.334	.109	.083	3.33	6.357	3.260	.134	.120	4.01	6.065	3.068	.280	.216	8.77
6x3-1/2	6.625	4.000	5-1/2	6.407	3.834	.109	.083	3.39	6.357	3.760	.134	.120	4.20	6.065	3.548	.280	.226	8.93
6x 4	6.625	4.500	5-1/2	6.407	4.334	.109	.083	3.41	6.357	4.260	.134	.120	4.31	6.065	4.026	.280	.237	8.99
6x 5	6.625	5.563	5-1/2	6.407	5.345	.109	.109	3.60	6.357	5.295	.134	.134	4.45	6.065	5.047	.280	.258	9.48
8 x3-1/2	8.625	4.000	6	8.407	3.834	.109	.083	4.65	8.329	3.760	.148	.120	6.48	7.981	3.548	.322	.226	14.10
8x 4	8.625	4.500	6	8.407	4.334	.109	.083	4.76	8.329	4.260	.148	.120	6.64	7.981	4.026	.322	.237	14.44
8x5	8.625	5.563	6	8.407	5.345	.109	.109	4.87	8.329	5.295	.148	.134	6.79	7.981	5.047	.322	.258	14.78
8x6	8.625	6.625	6	8.407	6.407	.109	.109	5.05	8.329	6.357	.148	.134	7.04	7.981	6.065	.322	.280	15.31
10x 4	10.750	4.500	7	10.482	4.334	.134	.083	8.34	10.420	4.260	.165	.120	10.43	10.020	4.026	.365	.237	23.19
10x5	10.750	5.563	7	10.482	5.345	.134	.109	8.62	10.420	5.295	.165	.134	10.78	10.020	5.047	.365	.258	23.96
10x6	10.750	6.625	7	10.482	6.407	.134	.109	8.82	10.420	6.357	.165	.134	11.03	10.020	6.065	.365	.280	24.52
10x8	10.750	8.625	7	10.482	8.407	.134	.109	9.17	10.420	8.329	.165	.148	11.46	10.020	7.981	.365	.322	25.48
12x5	12.750	5.563	8	12.438	5.345	.156	.109	13.72	12.390	5.295	.180	.134	16.07	12.000	5.047	.375	.258	33.48
12x6	12.750	6.625	8	12.438	6.407	.156	.109	14.01	12.390	6.357	.180	.134	16.38	12.000	6.065	.375	.280	34.13
12x8	12.750	8.625	8	12.438	8.407	.156	.109	14.45	12.390	8.329	.180	.148	16.91	12.000	7.981	.375	.322	35.24
12x10	12.750	10.750	8	12.438	10.482	.156	.134	15.03	12.390	10.420	.180	.165	17.60	12.000	10.020	.375	.365	36.67
14x6	14.000	6.625	13	13.688	6.407	.156	.109	23.78	13.624	6.357	.188	.134	29.00	13.250	6.065	.375	.280	58.00
14x8	14.000	8.625	13	13.688	8.407	.156	.109	25.10	13.624	8.329	.188	.148	30.61	13.250	7.981	.375	.322	61.22
14x10	14.000	10.750	13	13.688	10.482	.156	.134	26.05	13.624	10.420	.188	.165	31.77	13.250	10.020	.375	.365	63.55
14x12	14.000	12.750	13	13.688	12.438	.156	.156	27.64	13.624	12.390	.188	.180	33.71	13.250	12.000	.375	.375	67.42
16x8	16.000	8.625	14	15.670	8.407	.165	.109	32.39	15.624	8.329	.188	.148	36.81	15.250	7.981	.375	.322	73.62
16x10	16.000	10.750	14	15.670	10.482	.165	.134	34.37	15.624	10.420	.188	.165	39.06	15.250	10.020	.375	.365	78.12
16x12	16.000	12.750	14	15.670	12.438	.165	.156	35.60	15.624	12.390	.188	.180	40.45	15.250	12.000	.375	.375	80.91
16x14	16.000	14.000	14	15.670	13.688	.165	.156	36.48	15.624	13.624	.188	.188	41.46	15.250	13.250	.375	.375	82.92
18x10	18.000	10.750	15	17.670	10.482	.165	.134	40.78	17.624	10.420	.188	.165	46.34	17.250	10.020	.375	.365	92.69
18x12	18.000	12.750	15	17.670	12.438	.165	.156	41.66	17.624	12.390	.188	.180	47.35	17.250	12.000	.375	.375	94.70
18x14	18.000	14.000	15	17.670	13.688	.165	.156	42.48	17.624	13.624	.188	.188	48.28	17.250	13.250	.375	.375	96.56
18x16	18.000	16.000	15	17.670	15.670	.165	.165	43.64	17.624	15.624	.188	.188	49.60	17.250	15.250	.375	.375	99.20
20x12	20.000	12.750	20	19.624	12.438	.188	.156	71.50	19.564	12.390	.218	.180	71.50	19.250	12.000	.375	.375	143.00
20x14	20.000	14.000	20	19.624	13.688	.188	.156	72.50	19.564	13.624	.218	.188	84.10	19.250	13.250	.375	.375	145.00
20x16	20.000	16.000	20	19.624	15.670	.188	.165	73.00	19.564	15.624	.218	.188	84.68	19.250	15.250	.375	.375	146.00
20x18	20.000	18.000	20	19.624	17.670	.188	.165	75.50	19.564	17.624	.218	.188	87.58	19.250	17.250	.375	.375	151.00
24x16	24.000	16.000	20	23.564	15.670	.218	.165	98.02	23.500	15.624	.250	.188	98.02	23.250	15.250	.375	.375	169.00
24x18	24.000	18.000	20	23.564	17.670	.218	.165	100.00	23.500	17.624	.250	.188	100.00	23.250	17.250	.375	.375	173.00
24x20	24.000	20.000	20	23.564	19.624	.218	.188	103.00	23.500	19.564	.250	.218	103.00	23.250	19.250	.375	.375	179.00

CON. / ECC. REDUCERS

DIMENSIONS

unit : inch / lb

Nominal Pipe Size <small>Large End X Small End</small>	Outside Diameter Large End (O.D.)	Outside Diameter Small End (O.D.)	Length (H)	Schedule 80S					Schedule 160					XX Strong Wall				
				Inside Diameter Large End (I.D.)	Inside Diameter Small End (I.D.)	Wall Thickness Large End (T)	Wall Thickness Small End (t)	Approximate Weight **	Inside Diameter Large End (I.D.)	Inside Diameter Small End (I.D.)	Wall Thickness Large End (T)	Wall Thickness Small End (t)	Approximate Weight **	Inside Diameter Large End (I.D.)	Inside Diameter Small End (I.D.)	Wall Thickness Large End (T)	Wall Thickness Small End (t)	Approximate Weight **
5 x 2	5.563	2.375	5	4.813	1.939	.375	.218	7.25	4.313	1.689	.625	.343	12.03	4.063	1.503	.750	.436	14.50
5 x 2-1/2	5.563	2.875	5	4.813	2.323	.375	.276	7.93	4.313	2.125	.625	.375	13.16	4.063	1.771	.750	.552	15.86
5x3	5.563	3.500	5	4.813	2.900	.375	.300	8.55	4.313	2.624	.625	.438	14.19	4.063	2.300	.750	.600	17.10
5x3-1/2	5.563	4.000	5	4.813	3.364	.375	.318	8.80	-----	-----	-----	-----	-----	4.063	2.728	.750	.636	17.60
5x 4	5.563	4.500	5	4.813	3.826	.375	.337	9.11	4.313	3.438	.625	.531	15.12	4.063	3.152	.750	.674	18.22
6x2-1/2	6.625	2.875	5-1/2	5.761	2.323	.432	.276	10.88	5.187	2.125	.719	.375	18.06	4.897	1.771	.864	.552	21.76
6x3	6.625	3.500	5-1/2	5.761	2.900	.432	.300	12.15	5.187	2.624	.719	.438	20.17	4.897	2.300	.864	.600	24.30
6x3-1/2	6.625	4.000	5-1/2	5.761	3.364	.432	.318	12.67	-----	-----	-----	-----	-----	4.897	2.728	.864	.636	25.34
6x 4	6.625	4.500	5-1/2	5.761	3.826	.432	.337	13.14	5.187	3.438	.719	.531	21.81	4.897	3.152	.864	.674	26.28
6x 5	6.625	5.563	5-1/2	5.761	4.813	.432	.375	13.79	5.187	4.313	.719	.625	22.89	4.897	4.063	.864	.750	27.58
8 x3-1/2	8.625	4.000	6	7.625	3.364	.500	.318	17.61	-----	-----	-----	-----	-----	6.875	2.728	.875	.636	30.81
8x 4	8.625	4.500	6	7.625	3.826	.500	.337	20.36	6.813	3.438	.906	.531	36.85	6.875	3.152	.875	.674	35.63
8x5	8.625	5.563	6	7.625	4.813	.500	.375	21.32	6.813	4.313	.906	.625	38.50	6.875	4.063	.875	.750	37.31
8x6	8.625	6.625	6	7.625	5.761	.500	.432	22.32	6.813	5.187	.906	.719	40.30	6.875	4.897	.875	.864	39.06
10x 4	10.750	4.500	7	9.750	3.826	.500	.337	27.68	8.500	3.438	1.125	.531	62.30	-----	-----	-----	-----	-----
10x5	10.750	5.563	7	9.750	4.813	.500	.375	31.40	8.500	4.313	1.125	.625	70.60	-----	-----	-----	-----	-----
10x6	10.750	6.625	7	9.750	5.761	.500	.432	32.61	8.500	5.187	1.125	.719	73.30	-----	-----	-----	-----	-----
10x8	10.750	8.625	7	9.750	7.625	.500	.500	34.34	8.500	6.813	1.125	.906	77.10	-----	-----	-----	-----	-----
12x5	12.750	5.563	8	11.750	4.813	.500	.375	42.78	10.126	4.313	1.312	.625	112.00	-----	-----	-----	-----	-----
12x6	12.750	6.625	8	11.750	5.761	.500	.432	44.42	10.126	5.187	1.312	.719	116.00	-----	-----	-----	-----	-----
12x8	12.750	8.625	8	11.750	7.625	.500	.500	46.06	10.126	6.813	1.312	.906	120.00	-----	-----	-----	-----	-----
12x10	12.750	10.750	8	11.750	9.750	.500	.500	47.70	10.126	8.500	1.312	1.125	124.00	-----	-----	-----	-----	-----
14x6	14.000	6.625	13	13.000	5.761	.500	.432	77.81	11.188	5.187	1.406	.719	-----	-----	-----	-----	-----	-----
14x8	14.000	8.625	13	13.000	7.625	.500	.500	81.22	11.188	6.813	1.406	.906	-----	-----	-----	-----	-----	-----
14x10	14.000	10.750	13	13.000	9.750	.500	.500	85.40	11.188	8.500	1.406	1.125	-----	-----	-----	-----	-----	-----
14x12	14.000	12.750	13	13.000	11.750	.500	.500	88.97	11.188	10.126	1.406	1.312	-----	-----	-----	-----	-----	-----
16x8	16.000	8.625	14	15.000	7.625	.500	.500	97.49	12.812	6.813	1.594	.906	-----	-----	-----	-----	-----	-----
16x10	16.000	10.750	14	15.000	9.750	.500	.500	102.00	12.812	8.500	1.594	1.125	-----	-----	-----	-----	-----	-----
16x12	16.000	12.750	14	15.000	11.750	.500	.500	105.00	12.812	10.126	1.594	1.312	-----	-----	-----	-----	-----	-----
16x14	16.000	14.000	14	15.000	13.000	.500	.500	108.00	12.812	11.188	1.594	1.406	-----	-----	-----	-----	-----	-----
18x10	18.000	10.750	15	17.000	9.750	.500	.500	120.00	14.438	8.500	1.781	1.125	-----	-----	-----	-----	-----	-----
18x12	18.000	12.750	15	17.000	11.750	.500	.500	126.00	14.438	10.126	1.781	1.312	-----	-----	-----	-----	-----	-----
18x14	18.000	14.000	15	17.000	13.000	.500	.500	127.00	14.438	11.188	1.781	1.406	-----	-----	-----	-----	-----	-----
18x16	18.000	16.000	15	17.000	15.000	.500	.500	130.00	14.438	12.812	1.781	1.594	-----	-----	-----	-----	-----	-----
20x12	20.000	12.750	20	19.000	11.750	.500	.500	189.00	16.062	10.126	1.969	1.312	-----	-----	-----	-----	-----	-----
20x14	20.000	14.000	20	19.000	13.000	.500	.500	192.00	16.062	11.188	1.969	1.406	-----	-----	-----	-----	-----	-----
20x16	20.000	16.000	20	19.000	15.000	.500	.500	195.00	16.062	12.812	1.969	1.594	-----	-----	-----	-----	-----	-----
20x18	20.000	18.000	20	19.000	17.000	.500	.500	198.00	16.062	14.438	1.969	1.781	-----	-----	-----	-----	-----	-----
24x16	24.000	16.000	20	23.000	15.000	.500	.500	226.00	19.312	12.812	2.344	1.594	-----	-----	-----	-----	-----	-----
24x18	24.000	18.000	20	23.000	17.000	.500	.500	230.00	19.312	14.438	2.344	1.781	-----	-----	-----	-----	-----	-----
24x20	24.000	20.000	20	23.000	19.000	.500	.500	234.00	19.312	16.062	2.344	1.969	-----	-----	-----	-----	-----	-----

LAP- JOINT STUB END / SHORT TYPE "A" OR "B"

Stub Ends are supplied in Type A or Type B.
Type A is more readily available.

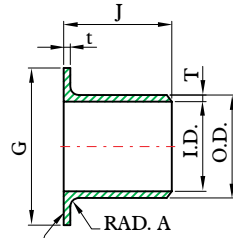

SERRATED FACE IN ACCORDANCE WITH ASME B16.5

TYPE A

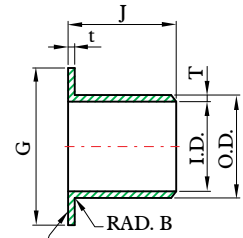

SERRATED FACE IN ACCORDANCE WITH ASME B16.5

TYPE B

Schedules 5S and 10S Stub Ends are usually supplied in Short Lengths; Long Lengths are available on special order.

Schedule 40S Stub Ends are supplied in either Short or Long Lengths.

DIMENSIONS

unit : inch / lb

Nominal Pipe Size	Outside diameter (O.D.)	Diameter (G)	Length (J)		Radius (A)		Schedule 40S			
			Short	Long	A	B	Inside Diameter (I.D.)	Wall Thickness (T)	Lap Thickness (t)	Approx. weight **
1/2	.840	1.375	2	3	1/8	1/32	.622	.109	.109	.19
3/4	1.050	1.688	2	3	1/8	1/32	.824	.113	.113	.26
1	1.315	2.000	2	4	1/8	1/32	1.049	.133	.133	.38
1-1/4	1.660	2.500	2	4	3/16	1/32	1.380	.140	.140	.55
1-1/2	1.900	2.875	2	4	1/4	1/32	1.610	.145	.145	.69
2	2.375	3.625	2-1/2	6	5/16	1/32	2.067	.154	.154	1.35
2-1/2	2.875	4.125	2-1/2	6	5/16	1/32	2.469	.203	.203	1.77
3	3.500	5.000	2-1/2	6	3/8	1/32	3.068	.216	.216	2.50
3-1/2	4.000	5.500	3	6	3/8	1/32	3.548	.226	.226	3.58
4	4.500	6.188	3	6	7/16	1/32	4.026	.237	.237	4.13
5	5.563	7.313	3	8	7/16	1/16	5.047	.258	.258	6.15
6	6.625	8.500	3-1/2	8	1/2	1/16	6.065	.280	.280	7.88
8	8.625	10.625	4	8	1/2	1/16	7.981	.322	.322	13.38
10	10.750	12.750	5	10	1/2	1/16	10.020	.365	.365	22.20
12	12.750	15.000	6	10	1/2	1/16	12.000	.375	.375	31.50
14	14.000	16.250	6	12	1/2	1/16	13.250	.375	.375	37.80
16	16.000	18.500	6	12	1/2	1/16	15.250	.375	.375	45.00
18	18.000	21.000	6	12	1/2	1/16	17.250	.375	.375	60.00
20	20.000	23.000	6	12	1/2	1/16	19.250	.375	.375	66.00
24	24.000	27.250	6	12	1/2	1/16	23.250	.375	.375	85.00

LAP- JOINT STUB END / STUB ENDS LONG TYPE "A"

All schedules of Long (ANSI Length) Stub Ends are usually supplied in Type A.

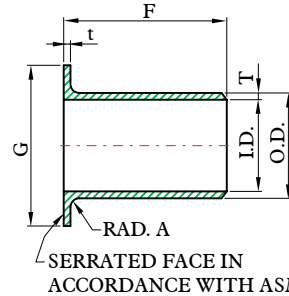

TYPE A

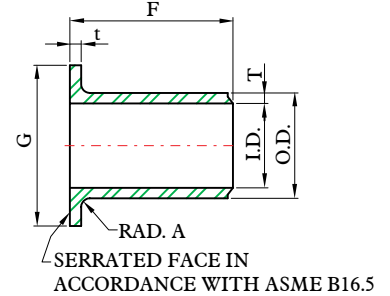

TYPE A

Schedules 80S 160 and XX Strong Wall Stub Ends are supplied in Long Lengths.
Short Lengths are available on special order.

DIMENSIONS

unit : inch / lb

Nominal Pipe Size	Outside diameter (O.D.)	Diameter (G)	Length (J)	Radius (A)	Schedule 40S				Schedule 80S			
					Inside Diameter (I.D.)	Wall Thickness (T)	Lap Thickness (t)	Approx. weight**	Inside Diameter (I.D.)	Wall Thickness (T)	Lap Thickness (t)	Approx. weight**
1/2	.840	1.375	3	1/8	.622	.109	.109	.26	.546	.147	.147	.34
3/4	1.050	1.688	3	1/8	.824	.113	.113	.36	.742	.154	.154	.47
1	1.315	2.000	4	1/8	1.049	.133	.133	.68	.957	.179	.179	.88
1-1/4	1.660	2.500	4	3/16	1.380	.140	.140	.97	1.278	.191	.191	1.26
1-1/2	1.900	2.875	4	1/4	1.610	.145	.145	1.20	1.500	.200	.200	1.49
2	2.375	3.625	6	5/16	2.067	.154	.154	2.25	1.939	.218	.218	3.05
2-1/2	2.875	4.125	6	5/16	2.469	.203	.203	3.40	2.323	.276	.276	4.40
3	3.500	5.000	6	3/8	3.068	.216	.216	4.65	2.900	.300	.300	6.50
3-1/2	4.000	5.500	6	3/8	3.548	.226	.226	5.89	3.364	.318	.318	7.75
4	4.500	6.188	6	7/16	4.026	.237	.237	6.83	3.826	.337	.337	9.65
5	5.563	7.313	8	7/16	5.047	.258	.258	11.88	4.813	.375	.375	16.33
6	6.625	8.500	8	1/2	6.065	.280	.280	15.18	5.761	.432	.432	22.63
8	8.625	10.625	8	1/2	7.981	.322	.322	23.81	7.625	.500	.500	34.12
10	10.750	12.750	10	1/2	10.020	.365	.365	39.50	9.750	.500	.500	54.00
12	12.750	15.000	10	1/2	12.000	.375	.375	48.50	11.750	.500	.500	64.50
14	14.000	16.250	12	1/2	13.250	.375	.375	63.00	13.000	.500	.500	84.00
16	16.000	18.500	12	1/2	15.250	.375	.375	73.50	15.000	.500	.500	98.00
18	18.000	21.000	12	1/2	17.250	.375	.375	99.00	17.000	.500	.500	136.00
20	20.000	23.000	12	1/2	19.250	.375	.375	108.00	19.000	.500	.500	157.00
24	24.000	27.250	12	1/2	23.250	.375	.375	139.00	23.000	.500	.500	178.00

LAP- JOINT STUB END / STUB ENDS LONG TYPE "A"

All schedules of Long (ANSI Length) Stub Ends are usually supplied in Type A.

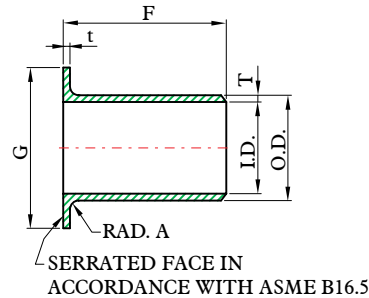

TYPE A

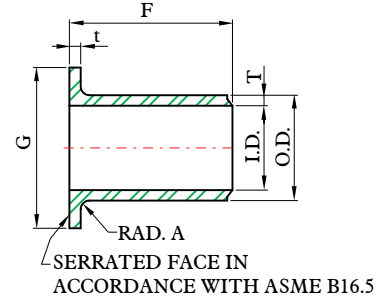

TYPE A

Schedules 80S 160 and XX Strong Wall Stub Ends are supplied in Long Lengths.
Short Lengths are available on special order.

DIMENSIONS

unit : inch / lb

Nominal Pipe Size	Outside diameter (O.D.)	Diameter (G)	Length (F)		Radius (A)	Schedule 160				XX Strong Wall			
			Short	Long		Inside Diameter (I.D.)	Wall Thickness (T)	Lap Thickness (t)	Approx. weight **	Inside Diameter (I.D.)	Wall Thickness (T)	Lap Thickness (t)	Approx. weight **
1/2	.840	1.375	2	3	1/8	.464	.188	.187	.43	.252	.294	.294	.68
3/4	1.050	1.688	2	3	1/8	.612	.219	.218	.66	.434	.308	.308	.94
1	1.315	2.000	2	4	1/8	.815	.250	.250	1.22	.599	.358	.358	1.76
1-1/4	1.660	2.500	2	4	3/16	1.160	.250	.250	1.64	.896	.382	.382	2.52
1-1/2	1.900	2.875	2	4	1/4	1.338	.281	.281	2.08	1.100	.400	.400	2.98
2	2.375	3.625	2-1/2	6	5/16	1.689	.343	.343	4.79	1.503	.436	.436	6.10
2-1/2	2.875	4.125	2-1/2	6	5/16	2.125	.375	.375	5.94	1.771	.552	.552	8.80
3	3.500	5.000	2-1/2	6	3/8	2.624	.438	.438	7.10	2.300	.600	.600	9.80
3-1/2	4.000	5.500	3	6	3/8	-----	-----	-----	-----	2.728	.636	.636	15.50
4	4.500	6.188	3	6	7/16	3.438	.531	.531	15.15	3.152	.674	.674	19.30
5	5.563	7.313	3	8	7/16	4.313	.625	.625	27.10	4.063	.750	.750	32.66
6	6.625	8.500	3-1/2	8	1/2	5.187	.719	.718	37.56	4.897	.864	.864	45.26
8	8.625	10.625	4	8	1/2	6.813	.906	.906	61.75	6.875	.875	.875	59.71
10	10.750	12.750	5	10	1/2	8.500	1.125	1.125	121.50	-----	-----	-----	-----
12	12.750	15.000	6	10	1/2	10.126	1.312	1.312	169.00	-----	-----	-----	-----

LAP- JOINT STUB END / STUB ENDS SHORT TYPE "C"

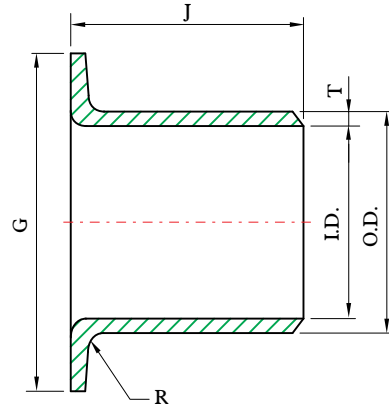

TYPE C

DIMENSIONS

unit : inch / lb

Nominal Pipe Size	Outside diameter (O.D.)	Diameter (G)	Length (J)	Radius (R)	Schedule 5S			Schedule 10S		
					Inside Diameter (I.D.)	Wall Thickness (T)	Approx. weight **	Inside Diameter (I.D.)	Wall Thickness (T)	Approx. weight **
1/2	.840	1.375	2	1/32	.710	.065	.13	.674	.083	.14
3/4	1.050	1.688	2	1/32	.920	.065	.14	.884	.083	.18
1	1.315	2.000	2	1/32	1.185	.065	.19	1.097	.109	.31
1-1/4	1.660	2.500	2	1/32	1.530	.065	.21	1.442	.109	.42
1-1/2	1.900	2.875	2	1/32	1.770	.065	.29	1.682	.109	.44
2	2.375	3.625	2-1/2	1/32	2.245	.065	.44	2.157	.109	.81
2-1/2	2.875	4.125	2-1/2	1/32	2.709	.083	.75	2.635	.120	1.00
3	3.500	5.000	2-1/2	1/32	3.334	.083	.94	3.260	.120	1.25
4	4.500	6.188	3	1/32	4.334	.083	1.38	4.260	.120	1.88
5	5.563	7.313	3	1/16	5.345	.109	2.06	5.295	.134	2.63
6	6.625	8.500	3-1/2	1/16	6.407	.109	2.75	6.357	.134	3.56
8	8.625	10.625	4	1/16	8.407	.109	3.88	8.329	.148	6.19
10	10.750	12.750	5	1/16	10.482	.134	7.48	10.420	.165	9.46
12	12.750	15.000	6	1/16	12.438	.156	15.00	12.390	.180	16.07
14	14.000	16.250	6	1/16	13.688	.156	19.20	13.624	.188	23.10
16	16.000	18.500	6	1/16	15.670	.165	23.90	15.624	.188	27.20
18	18.000	21.000	6	1/16	17.670	.165	28.50	17.624	.188	32.40
20	20.000	23.000	6	1/16	19.624	.188	36.30	19.564	.218	47.70
24	24.000	27.250	6	1/16	23.564	.218	56.00	23.500	.250	58.27